



Meaningful Innovation.

WEEE Number: 80133970

# INSTRUCTION MANUAL

## ESS SERIES BATTERY PACK

### INTRODUCTION



Thank you for selecting and buying V-TAC Product. V-TAC will serve you the best. Please read these instructions carefully & keep this user manual handy for future reference. If you have any another query, please contact our dealer or local vendor from whom you have purchased the product. They are trained and ready to serve you at the best.

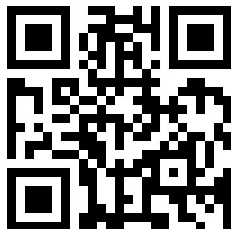

### Multi-Language Manual QR CODE

Please scan the QR code to access the manual in multiple languages.

# 1 Foreword

## ► Overview

This user manual mainly introduces the 48V 200Ah series product introduction, application description, installation instructions, power-on instructions, maintenance instructions and provides instructions for technical support engineers, maintenance engineers and users.





## ► Reader

This document is mainly applicable to the following engineers

- Technical Support Engineer
- Installation Personnel
- Maintenance Engineer

## ► Signs

The following signs may appear in this article, and their meanings are as follows.

Sign	Meaning	Description
	Danger	Indicates a hazard with a high level of risk that will cause death or serious injury if not avoided.
	Warning	Indicates a hazard with a moderate risk that may cause death or serious injury if not avoided.
	Notice	Indicates a hazard with a low level of risk that may cause minor or moderate harm if not avoided.
 NOTE	Explanation	Supplementary explanation of key information in the main text. "Explanation" is not safety warning information, and does not involve personal, equipment and environmental damage information.

## 2 Safety

### ▶ 2.1 Safety Precautions

Before carrying out battery work, you must read carefully the safety precautions and master the correct installation and connection methods of the battery.

- Prohibit to turn it upside down, tilt, or collide.
- Prohibit to short-circuit the positive and negative poles of the battery, otherwise it will cause the battery to be damaged.
  - Prohibit to throw the battery pack into a fire source.
  - Prohibit to modify the battery, and it is strictly prohibited to immerse the battery in water or other liquids.
    - DO NOT place installation tools on the battery during battery installation.
    - DO NOT disassemble, squeeze, bend, deform, puncture, or shred the battery without the authorization of Vestwoods and authorized dealers.
      - DO NOT exceed the temperature range, otherwise it will affect the battery performance and safety.
        - The battery circuit must be kept disconnecting status during installation and maintenance operations.
        - Check the battery connection end bolts regularly to confirm that the bolts are tight.

### ▶ 2.2 Abuse Operation

The battery pack needs to avoid abuse operations under the following (including but not limited to) conditions:

Abuse Operation	Protection Description
Reverse connection of positive and negative poles	If the positive and negative poles are connected reversely, the battery will be directly damaged.
External short circuit	If the battery pack is short circuited externally, the battery will be directly damaged.
Series connection application	The battery pack does not support the application of battery packs in series. If the battery packs are forced to be connected in series, the batteries may be directly damaged, and may even cause fire, explosion and other dangers.

---

## 3 Overview

---

### ▶ 3.1 Product Description

The 48V 200Ah series products use lithium iron phosphate (LFP) as the positive electrode material. It can be widely used in telecom scenario and energy storage systems such as off-grid, grid-connected, and home use.

The battery pack is composed of 15 cells/16 cells of LFP batteries in series connection, with low self-discharge, high energy density, and no memory effect. This type of battery also has excellent performance in high rate, long cycle life, wide temperature range, and high safety.

#### ▶ 3.1.1 Features

- **High energy density**

Higher volume ratio energy and weight ratio energy.

- **Maintenance-free**

The battery pack is maintenance-free in the process of using, which can save customers' battery operation, maintenance testing costs and reduce the frequency of on-site replacement.

- **Long cycle life**

The battery pack life is 3 times long than the ordinary lead-acid batteries.

- **Excellent temperature characteristics**

When charging, the battery working temperature can reach 0°C ~ +60°C(recommended using temperature: +15 ~ +35°C). When discharging, the battery working temperature can reach -20°C ~ +60°C(recommended using temperature: +15 ~ +35°C).

#### ▶ 3.1.2 Basic Functions

- **Monitor**

The battery system uses a high-performance BMS, it has protection functions such as current, voltage.

- **Alarm**

Support abnormal alarms such as overvoltage, under-voltage, overcurrent, short circuit, high and low temperature, battery failure, hardware failure, etc.

- **Communication**

Provide dual RS485 interfaces, upload alarming and status data through the RS485/CAN communication protocol.

---



### 3 Overview

- **Parallel connection application**

Support multiple battery packs in parallel, RS485/CAN communication supports up to 6 groups without control unit (or max supports 15 groups with control unit) .

- **Balance function**

Support the cells balance function.

- **Extended function**

Extended SNMP V2, SNMP V3, LCD, anti-theft, etc.

### ▶ 3.2 Application Scenario

The battery pack is used to provide backup power to the power system, and can be used for telecom, household energy storage, solar energy storage and other application scenarios.

The normal working operation diagram of the battery pack can be as shown in the figure below.

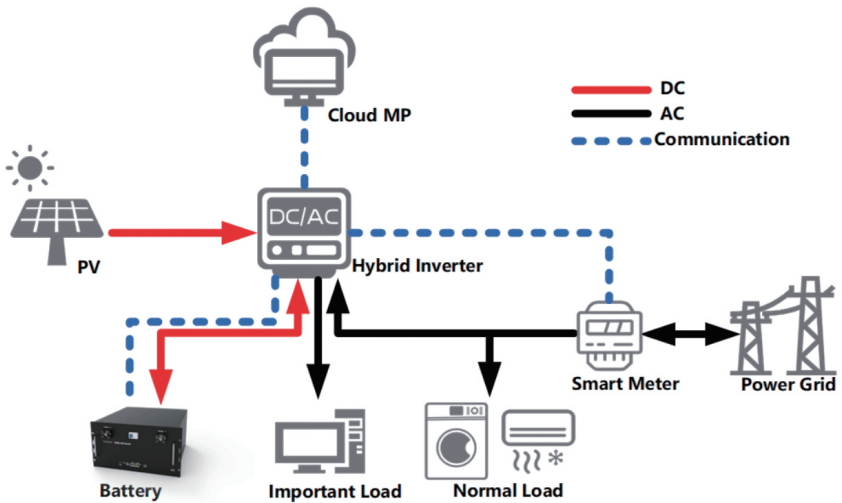
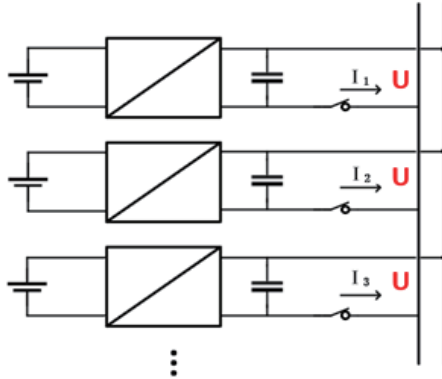

Figure 3-1 Normal Working Operation Diagram of The Battery pack

## 4 Application Description

### ▶ 4.1 Parallel Connection Application



The battery packs support parallel connection, and synchronously increases the backup time or backup power.

Multiple battery packs of parallel connection need to use RS485/CAN to communicate, pay attention to the DIP switch settings. Turn off the batteries before connecting them in parallel.

### ▶ 4.2 Low-temperature Application

#### • Low-temperature Charging

The battery pack does not support direct charging of the battery below  $0^{\circ}\text{C}$ . When the minimum temperature of the battery is below  $0^{\circ}\text{C}$ , the BMS will cut-off the charging circuit and cannot be charged.

#### • Low-temperature Discharging

The battery pack does not support discharge below  $-20^{\circ}\text{C}$ . When the minimum temperature of battery is below  $-20^{\circ}\text{C}$ , the BMS will cut-off the discharge circuit and cannot discharge.

### ▶ 4.3 Low battery-capacity Storage (SOC $\leq$ 5%)

After the battery pack is power off, there will be BMS static power consumption and self-discharge loss. In actual scenarios, it is necessary to avoid low-battery-power state (SOC $\leq$ 5%) storage. If it is unavoidable, the longest storage period is 30

---

## 4 Application Description

---

days@25°C, 15 days@45°C. The battery needs to be recharged in time after storage, otherwise the battery may be damaged due to over-discharge, and the entire battery pack needs to be replaced.

The following conditions may cause the battery pack to be stored in a discharged state:

- After the utility power failure, the line/fault cannot be eliminated in time, and the power supply cannot be restored for a long time.
- After the installation and commissioning work is completed, the utility power is turned off directly, but the battery pack is not powered off, which will cause the battery to enter the low power consumption mode.
- Other reasons cause the battery pack to fail to enter low power consumption normally.

### ▶ 4.4 Application of Nearing the Ocean

The atmospheric corrosion environment is defined and classified according to the natural environment state, and the A/B environment is defined as follows:

- A: environment refers to the ocean or the land near the pollution source, or the environment with simple shelter (such as awning). "Near the ocean" refers to the area 0.5 ~ 3.7km away from the ocean; "Near the pollution source" refers to the area within the following radius: 3.7km from the saltwater lake, 3km from heavy pollution sources such as smelters, coal mines, and thermal power plants, chemical industry, rubber, electroplating, etc. 2km from medium pollution sources such as chemical industry, rubber and electroplating, etc. And 1km from light pollution sources such as food, leather and heating boilers, etc.

- B: environment. Refers to the environment on land or outside with simple shelter (such as awning) within 500m from the coast, or the environment on the sea.

---

#### NOTE

The battery pack can be used under other environmental conditions and cannot be used alone under A/B environment. If it is to be used in the A/B environment, it needs to be equipped with a high-protection air-conditioning cabinet, which is recommended to be IP55 or higher.

---

## 5 Product Introduction

### 5.1 Panel Introduction

#### 5.1.1 Panel Function

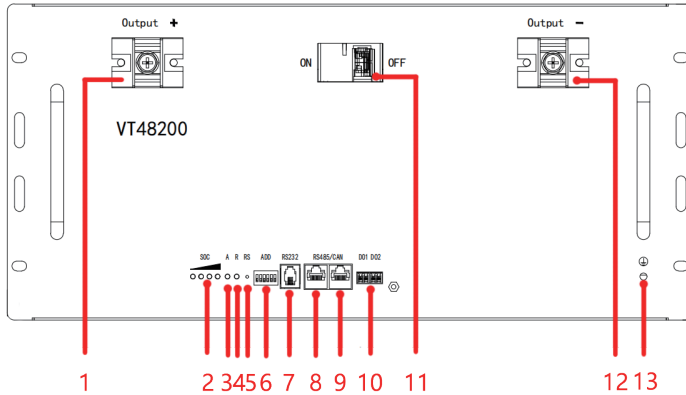

Figure 5-1 Front Panel

The interface definition as below table:

Table 5-1 Operation Panel Interface Definition

No.	Name	Description	Remark
1&12	Battery Output	Power terminal	-
2	SOC	State of charge	Details shows in table 5-2
3	ALM	Alarm light	Details shows in table 5-4
4	RUN	Run status of battery	Details shows in table 5-3
5	RESET	Reset switch	-
6	ADD	Dip switch	Address range 0~15
7	RJ-11	RJ-11 interface for firmware update	Used for debugging
8&9	RJ-45/CAN	2*RJ-45 interface for RS485/CAN communication	Details shows in table 5-7
10	Dry Contact	NC. / NO. dry contact	Dry contact definition shows in table 5-8
11	Switch	Power switch	-
13	GND	Module ground connection	-

## 5 Product Introduction

### 5.1.2 Indicator Description

There are 6 Indicators on the operation panel, divided into three categories: 4 green SOC Indicators, 1 red alarm Indicator and 1 green run indicator.

The power indicator is used to identify the current capacity status of the battery. The number of flashing indicators corresponds to different remaining capacity. The specific meaning is shown in the following table.

Table 5-2 SOC Indicator Definition

Status		LED			
SOC indicator		L4	L3	L2	L1
SOC	0~10%	Flash 2	OFF	OFF	OFF
	10~25%	ON	OFF	OFF	OFF
	25~50%	ON	ON	OFF	OFF
	50~75%	ON	ON	ON	OFF
	75~100%	ON	ON	ON	ON

Table 5-3 RUN Indicator Definition

Flash Mode	ON	OFF	Module Status
Flash 1	0.25 s	3.75 s	Idle
Flash 2	0.5 s	0.5 s	Charge
Flash 3	0.25 s	0.25 s	Start up failed
Keep On	-		Discharge
Keep Off	-		Sleep/Fault

## 5 Product Introduction

Table 5-4 Alarm Indicator Definition

Indication Status	ON	OFF	Module Status
Flash 2	0.5 s	0.5 s	Alarm (Cell Over-voltage, Cell Under-voltage)
Keep On	-		Fault (Charge/Discharge MOS, NTC, BQ940, ADC Fault, Battery lock)
Keep Off	-		Standby/Sleep

The corresponding relationship between battery operation status and indicator operation status is shown in the following table.

Table 5-5 Battery Status and Indicator Operation Mode

Battery status	Normal/ Abnormal	RUN	ALM	SOC Indicators				Description
-	-	Green	Red	Green	Green	Green	Green	-
Power off/ Sleep	-	OFF	OFF	OFF	OFF	OFF	OFF	-
Standby	Normal	Flash 1	OFF	According to SOC				Flash mode shown in Table 2
Charge	Normal	Flash 2	OFF	According to SOC				-
Discharge	Normal	ON	OFF	According to SOC				-
Alarm	Abnormal	According to the state of charge and discharge	Flash 2	According to SOC				Recoverable
Error	Abnormal	OFF	ON	OFF				-

## 5 Product Introduction

### 5.1.3 DIP Address

To communicate with the battery, you need to assign an address to the battery BMS through the DIP switch.

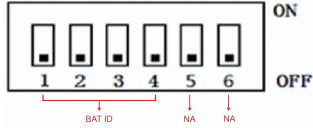

The relationship between DIP address and BMS address as below:

Table 5-6 Correspondence between BMS and DIP Switch

DIP 1	DIP 2	DIP 3	DIP 4	BMS Address	BMS Address
OFF	OFF	OFF	OFF	0	
ON	OFF	OFF	OFF	1	
OFF	ON	OFF	OFF	2	
ON	ON	OFF	OFF	3	
OFF	OFF	ON	OFF	4	
ON	OFF	ON	OFF	5	
OFF	ON	ON	OFF	6	
ON	ON	ON	OFF	7	
OFF	OFF	OFF	ON	8	
ON	OFF	OFF	ON	9	
OFF	ON	OFF	ON	10	
ON	ON	OFF	ON	11	
OFF	OFF	ON	ON	12	
ON	OFF	ON	ON	13	
OFF	ON	ON	ON	14	
ON	ON	ON	ON	15	

## 5 Product Introduction

### NOTE

When batteries are used in parallel, the DIP address of the master pack is set to 1 by default. Therefore, DIP address '1' cannot be used for battery communication.

### 5.1.4 Communication Port Definition

RJ 45 definition as below:

Table 5-7 RJ 45 Definition

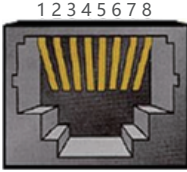
RJ 45/CAN Photo	Pin	Description
	4	RS485_A
	5	CAN_L
	6	CAN_H
	7	RS485_B
	8	GND
	1/2/3	NC

### 5.1.5 Dry Contact Alarm Definition

The module uses the default NC. dry contact to provide alarm signals. The alarm definition of the dry contact is defined as follows.

Table 5-8 Dry Contact Alarm Definition

Dry Contact No.	Alarm Definition
Dry Contact 1	SOC $\leq$ 20%
Dry Contact 2	Battery lock; 940 module fault; NTC disconnection; Single cell voltage is lower than 1V; Charging and discharging MOS fault; Voltage gap between cells is more than 800mV.



## 6 Installation

















### 6.1 Tools Preparation

#### ATTENTION

Use insulated tools to avoid electric shock. If you use tools without insulation protection, you need to wrap the exposed metal parts with insulation tape for insulation treatment.

The following table describes the tools and meters that may be used before installation.

Table 6-1 Installation

Manual forklift 	Electric forklift 	Electric screw driver 	Adjustable wrench 
Phillips screwdriver 	Slotted screwdriver 	Torque wrench 	Claw Hammer 
Socket wrench 	Multimeter 	Protective gloves 	Helmet 
Insulated shoes 	Anti-static gloves 	Goggles 	Insulating tape 

## 6 Installation

### ▶ 6.2 Unpacking and Inspection

- Study this manual carefully before any installation of the batteries.
- The batteries must only be installed and operated by trained personnel.
- Check the quantity of battery and accessories with delivery list.
- Check the appearance whether there is damaged or leakage, if any damage is detected, please do not proceed to the next installation.

### ▶ 6.3 Preparing for Installation

- Make sure to disconnect and isolate the battery from any electrical source, and then turn on the MCB (switch). Verify that the red ALM LED does not stay on for more than 30 seconds.
- Turn off the switch and continue with the installation.

### ▶ 6.4 Installation

- 1 Make sure the battery is in off status. As shown in Figure 6-1.

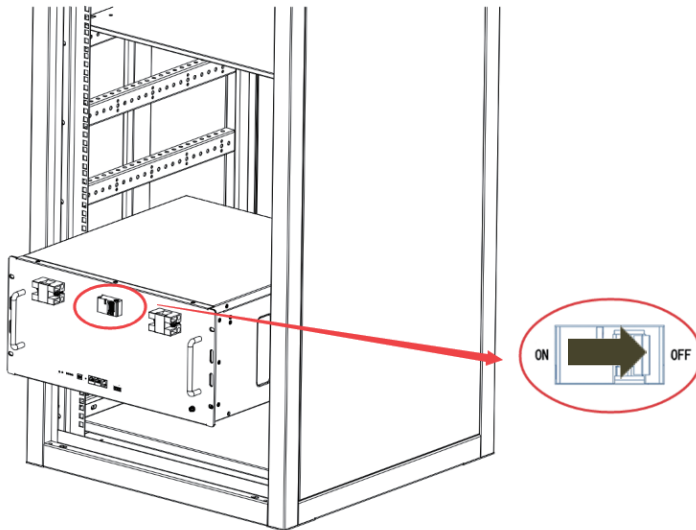

Figure 6-1 Make Sure the Battery is in Off Status

## 6 Installation

- 2 Put the battery into cabinet or rack. As shown in Figure 6-2.

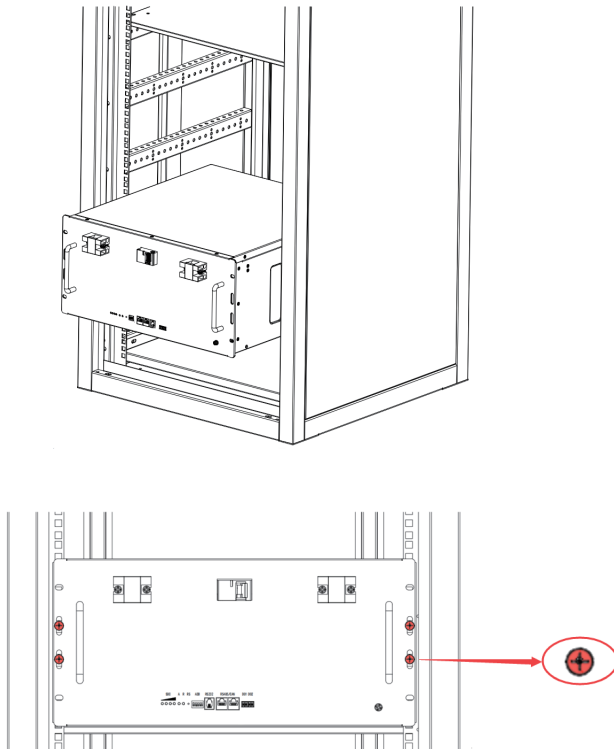

Figure 6-2 Fix the Battery on the Cabinet or Rack

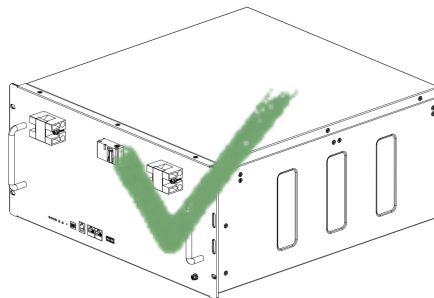

Figure 6-3 Right Way to Place Battery

## 5 Product Introduction

---

### NOTE

- The 48V 200Ah series batteries can be applied to install in 19-inch rack / existing cabinets.
  - The 48V 200Ah series batteries preferred to be installed in flat position as Fig 6-3 shown.
  - The battery must be fixed tightly with 4pcs M6\*25 crown screws.
  - The grounding screw is M5\*12.
  - In case of several battery parallel connection, it is advisable to leave a space of at least 10mm between them.
- 

## 6.5 Cable Connection

- Pay attention to the polarity of the battery pack.
- Connect the negative power cables of all battery packs first, and then connect the positive power cables of the battery packs.

### 1 Connect Ground Cable

Take out the ground wires and connect one end to the ground point of the battery pack and other end to the ground point of the cabinet.

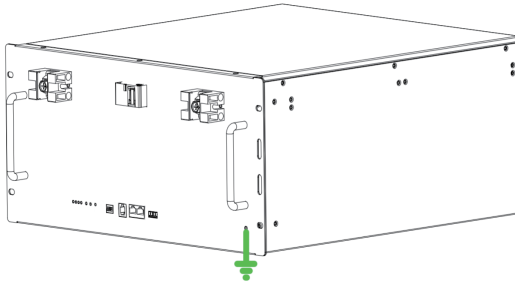

Figure 6-4 Connect Ground Cable

## 2 Connect Power cable

Use the negative power cable to connect the negative bus bar with the battery negative ( '-' ) terminal, and use the positive power cable to connect the positive bus bar with the battery positive ( '+' ) terminal.

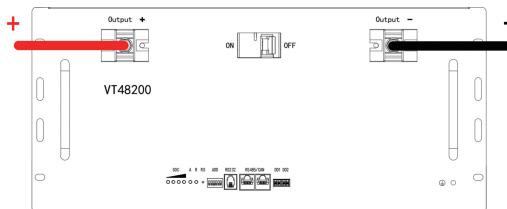

Figure 6-5 Connect the Battery Pack Power Cable

## 3 Connect Communication Cable

A. Use the communication cable to connect the battery packs in series through the RS485 communication port, and connect the battery packs at the end to the user's RS485 communication port through the RS485 communication port.

B. Assign addresses to battery packs. Assign addresses to battery packs by dialing the dialing keys of the dialing switch. Please refer to 5.2.3 about the correspondence between DIP switch and battery pack address.

External Device

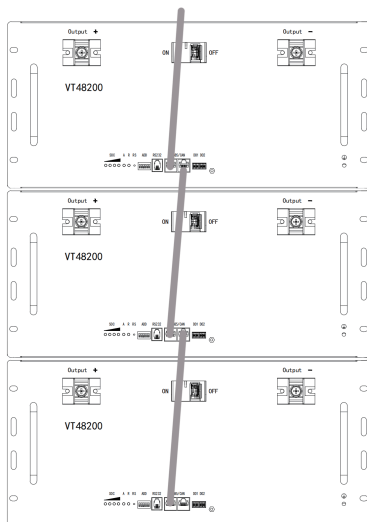

Figure 6-6 Connect RS485 Communication Cable

## 6 Installation

### 4 120Ω Resistor Connection

To ensure stable CAN communication with the inverter when batteries are used in parallel, please take out a 120Ω resistor from the 'Battery Kit' and insert it into the RJ45 port of the battery that communicates farthest with the inverter.

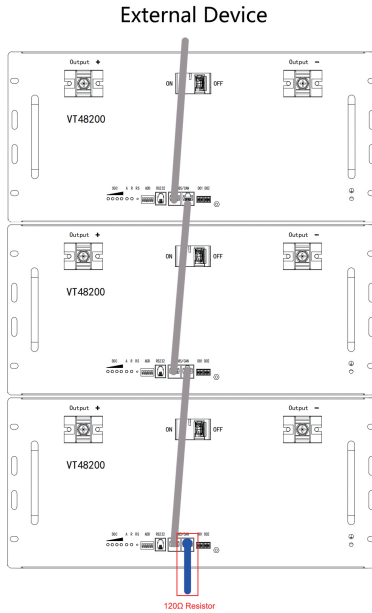

Figure 6-7 Connect the 120Ω Resistor

### ATTENTION

- Wear safety protection equipment to prevent electric shock from causing electric shock injuries.
- Use insulated tools to avoid electric shock.
- Communication cables and power cables must be laid separately.
- Before connecting cables, make sure that the bus-bars at the user end are in disconnected state.
- Pay attention to the polarity of the battery pack.

## 7 Power On

### 7.1 Power-on Operation

#### 7.1.1 Pre-check Preparing Power-on Operation

After completing the installation of the battery, users need to perform a pre-power check to ensure that the device installation and cable connection are correct.

- Check whether the cables are connected correctly, and the connectors are fastened.
- Check whether the battery pack's power cable terminal is snapped into place and covered with an insulating cover.
- Check whether the long cables are bundled.
- Check whether the communication cable and the power cable are separated.
- Check whether the cabinet, battery pack are grounded.

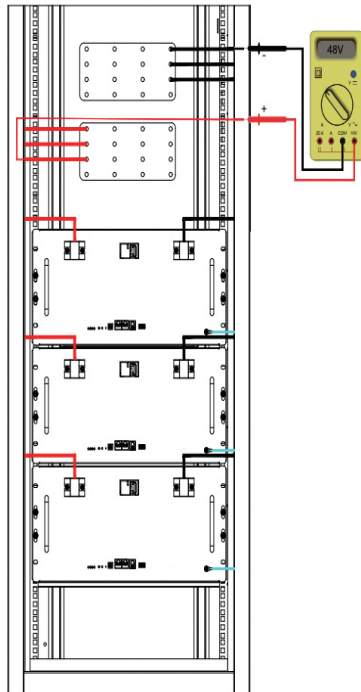

Figure 7-1 Check the Battery Voltage

---

## 7 Power On

---

### 7.1.2 Power On

- 1 Power on the charger/inverter at the user terminal.
- 2 Set the battery MCB/Switch to ON (if available).
- 3 Observe Run/Alarm indicator and judge the battery operating status. If the RUN indicator of the battery is on and the ALARM indicator is off, indicating that the battery is working normally.
- 4 Please configure the actual number of batteries in parallel connection through the UIWare. As follows.

---

#### NOTE

- This section is for professionals only and requires specific tools and software. Currently only open to growcol accredited engineers.
-



## 7 Power On

### 7.1.3 UIWare Configuration

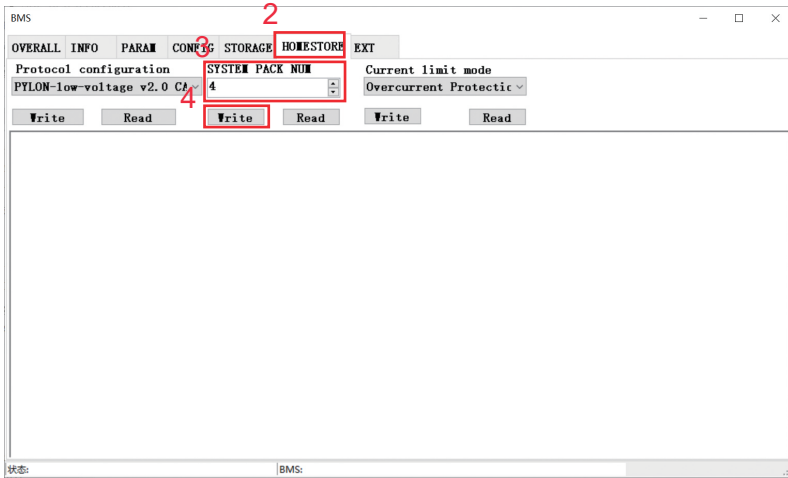

Figure 7-2 Configuration Page

- 1 Connect the UIWare by computer successfully.
- 2 Click the 'HOMESTORE' page.
- 3 Select the actual number of batteries in parallel connection on the 'SYSTEM PACK SUM'
- 4 Click the 'Write' button to finish the setting.
- 5 Restart the battery.

#### NOTE

- Please refer to the "UIWare User Manual" for more UIWare operations.

## 7 Power On

### NOTE

• Please refer to the section 7.2 to get information of battery system parameter setting, refer to the section 5.2.2 to get information of indicator description.

### WARNING

- Follow the power-on procedure to power on the battery pack strictly .
- Make sure to turn on the charger/inverter firstly, before turning on the battery MCB/Switch.
- Must not change the parameters casually in the site.
- After VT48200B series batteries goes into the sleeping status, please turn on the Battery MCB/Switch against or press the reset button.

### 7.1.4 Check by UI software

Connect the PC UI software to confirm the system running information been displayed normally. If the displays normally, then we can know the battery is well and the parameter settings are right.

The screenshot displays the BMS UI software interface. The main window is titled 'BMS' and shows a 'PARAM' tab. The 'PARAM' tab contains a table with columns for 'Caption', 'Value', and 'Unit'. The table lists various parameters such as 'valid\_disg\_count', 'Capacity\_Full', 'Remain\_Disg\_Time', 'TEMP1', 'TEMP2', 'TEMP3', 'TEMP4', 'PCB\_TEMP', 'ENV\_TEMP', 'Current', 'chg\_total\_ah', 'disg\_total\_ah', 'chg\_total\_time', 'disg\_total\_time', 'chg\_total\_Mh', 'disg\_total\_Mh', 'last\_disg\_ah', and 'SOH'. The 'Value' column shows numerical values, and the 'Unit' column shows units like '#', 'Ah', 'h', '°C', 'A', 's', 'Mh', and '#'. The 'Unit' column also includes a 'Unit' column with a dropdown menu.

Below the table, there are several status indicators and controls:

- Protect Status:** Includes 'No\_Voltage\_Protect', 'No\_Current\_Protect', 'No\_Temp\_Protect', and 'No\_ShortCurrent\_Reverser'.
- Alarm Status:** Includes 'No\_Voltage\_Alarm', 'No\_Current\_Alarm', and 'No\_Temp\_Alarm'.
- Bussel Status:** Includes 'SOC 100.00%', 'SOH 100.00%', 'AlarmClear 00:00:00.00.00.00', 'FireVer', 'BusVer', 'SR', 'Cmpswr', 'Prdust', 'Prdustor', and 'Time'.
- Anti-theft:** Includes 'Anti-theft: CYRO\_ACTIVATE' and 'Anti-theft state: CYRO\_UNLOCK'.
- Buttons:** 'Unlock', 'Lock', 'Adjust XYZ', and 'Opt result: \*\*\*\*\*'.

Figure 7-3 Page of UI Software

---

## 7 Power On

---

### WARNING

- Details refer to the “Operation Manual of the VM UI Software” .
  - Please recharge the battery before put into use according to this manual.
- 

## 7.2 Power System Parameter Setting

Table 7-1 Parameter Setting

No.	Parameters	Units	Standard Value	
			15S	16S
1	Equalization charge voltage	V	54.1	56.5
2	Float charge voltage	V	54.0	56.4
3	Standard charge current	A	0.2C	0.2C
4	Charge current limitation	A	20.0	20.0
5	Condition to equalization charge	A	NA	NA
6	Condition to float charge	A	0.05C	0.05C
7	Recovered LLVD voltage	V	50.0	53.3
8	LLVD	V	47.0	50.1
9	BLVD	V	43.2	46.1
10	Temperature compensation for float charge	-mV/°C	NA	NA
11	Temperature compensation for equalization charge	-mV/°C	NA	NA

---

### NOTE

- The content in the table is just our suggestion, and actually need to refer to other related requirements.
  - The setting items of different chargers will be different.
-

---

## 8 Shipment & Maintenance & Storage

---

### ▶ 8.1 Shipment

It is suitable for the transportation of vehicles, ships and airplanes. During transportation, shading, sun protection and civilized loading and unloading should be performed. The box containing the product is allowed to be transported by any means of transportation. In the process of loading and unloading, the battery should be handled with care to prevent falling, rolling, and heavy pressure. Avoid direct rain and snow and mechanical impact during transportation.

And here is the suggestion for the initial SOC before shipment by different transportation:

- Airplane:30%
- Sea:50%
- Vehicle:50%

---

#### NOTE

• Whether the loading SOC status of the battery is allowed, you need to consult the relevant government transportation department.

---

### ▶ 8.2 Maintenance

#### ▶ 8.2.1 Battery Maintenance Considerations

When maintaining the battery, it is required to use insulated tools or wrap the tools in insulation.

- DO NOT place any debris on the top of the battery.
- DO NOT use any organic solvents to clean the battery.
- DO NOT smoke or use naked flames near the battery.
- After the battery is discharged, the battery should be charged in time to avoid affecting the battery life.
  - When not using the battery for a long time, please charge the battery to 40%~50% charged state. Long-term storage with low battery may damage the battery.
  - All maintenance work must be carried out by professionals.

---

## 8 Shipment & Maintenance & Storage

---

### 8.2.2 Routine Maintenance

The staff should perform visual inspection on VT48 series battery according to the inspection plan, please refer to the following table for maintenance.

Table 8-1 Routine Maintenance (Every three-month)

Items	Standard	Dealing
Battery Appearance	<ul style="list-style-type: none"><li>• The surface is neat and clean without stains.</li><li>• The terminals are in good condition.</li><li>• The battery pack shell is intact, and there is no bumps, breaks, or leakage.</li><li>• The appearance of the battery pack does not leak.</li><li>• No deformation or swelling of the shell.</li></ul>	<ul style="list-style-type: none"><li>• If the surface is dirty, clean the appearance of the battery pack with a cotton cloth.</li><li>• The battery pack terminal is damaged, replace the cable.</li><li>• If the appearance is damaged, leaking or deformed, take a photo and replace the defective battery pack.</li><li>• Please contact Vestwoods in time for other abnormal situations.</li></ul>
Alarm	<ul style="list-style-type: none"><li>• No Alarm.</li></ul>	<ul style="list-style-type: none"><li>• Find the solution as per alarm information.</li></ul>

---

#### NOTE

- Suggested routine maintenance for every three-month.
-

## 8 Shipment & Maintenance & Storage

Table 8-2 Routine Maintenance (Every six-month)

Items	Standard	Action
(Suggested) Complete Cycle	<ul style="list-style-type: none"> <li>Have a complete charge &amp; discharge cycle under the equipment no lack of power.</li> </ul>	<ul style="list-style-type: none"> <li>Check whether happens alarm action, and please check with the alarm list.</li> <li>Please contact with Vestwoods if the alarm still exists.</li> </ul>
Cables	<ul style="list-style-type: none"> <li>There is no aging of the connecting wire and no cracking of the insulation layer.</li> <li>The bolts at the cable connection are not loose.</li> </ul>	<ul style="list-style-type: none"> <li>Replace the faulty connection.</li> <li>Fastening bolts.</li> </ul>

### 8.3 Battery Storage

- The recommended storage temperature is 15°C~35°C.
- Battery performance degradation after long-term storage, please shorten shelf time as possible as you can.
  - Recharge charge before using to recover capacity loss of self-discharge during storage and transport.
  - Storage battery should be at 40%-50%SOC when the battery is not used for a long time.
    - Storage battery over 40°C or under 0°C will reduce battery life.
    - Storage battery in dry and low temperature, well ventilated place.

If the battery is not used for a long time, the battery must be charged at regular intervals. The charging requirements are as follows:

Table 8-3 Battery Charge Requirement in Storage Status

Storage Temp.	Charge Period	Charge Process
20°C~30°C	Each 6 months	1.Charge by 0.2C to 100% SOC 2.Discharge by 0.2C to 0% SOC 3.Charge by 0.2C to 40%~50% SOC
0°C~20°C or 30°C~40°C	Each 3 months	

## 9 Trouble Shooting

Please refer to the table below to deal with common faults:

Table 9-1 FAQ

Phenomenon	Possible Cause	Solution
The indicator does not flash	The power cable of the battery pack is not properly connected.	Reconnect the power cable of the battery pack
	The power switch is off.	Turn on the power switch.
	The BMS is in a sleep state.	Charge the battery pack
	BMS is damaged.	Replace BMS.
Unable to discharge	The terminal of the battery pack is damaged.	Replace the battery pack wiring terminals.
	BMS communication failure.	Reconnect the communication line between the BMS and the battery pack. If the communication cable is damaged, replace the communication cable.
	The power switch is off.	Turn on the power switch.
Unable to charge	The charger is malfunctioning.	Replace the charger.
	The terminal of the battery pack is damaged.	Replace the battery pack wiring terminals.
	BMS communication failure.	Reconnect the communication line between the BMS and the battery pack. If the communication cable is damaged, replace the communication cable.
	The power switch is off.	Turn on the power switch.
Communication fail	The power switch is off.	Turn on the power switch.
	The BMS is in a sleep status.	Charge the battery pack
	The communication cable is damage.	Replace the network cable.
Inaccurate voltage display	The voltage sampling line is damaged.	Replace the voltage sampling cable.
	BMS is damaged.	Replace BMS.
Low capacity	The battery pack has not been maintained for a long time.	Use an equalizer to maintain the battery pack.
	The single battery is damaged.	Replace the damaged single battery.
	Inaccurate voltage sampling.	Replace the electrical sampling line or replace the BMS.
Low cell voltage	The battery pack has not been maintained for a long time.	Use an equalizer to maintain the battery pack.
	The single battery is damaged.	Replace the damaged single battery.
	Inaccurate voltage sampling.	Replace the electrical sampling line or replace the BMS.

---

## 10 Warranty

---

Except for the following and the conditions specified in the contract, you can go to Vestwoods and authorized dealers for reasonable warranty and maintenance.

1 Failure of equipment caused by unauthorized disassembly and maintenance operations without the authorization of Vestwoods and authorized dealers is not within the scope of the warranty.

2 Equipment damage caused by negligence during storage and transportation is not covered by the warranty.

3 The damage to the equipment caused by continuous overload work outside the electrical parameters of the equipment is not covered by the warranty.

4 Unauthorized testing of the equipment without the authorization of Vestwoods and authorized dealers will not be covered by the warranty.

5 Non-equipment problems, adverse consequences caused by operation and matching problems are not covered by the warranty.

6 Equipment damage caused by natural forces, force majeure, and uncontrollable factors, such as earthquakes, typhoons, tornadoes, volcanic eruptions, floods, lightning, heavy snow, and wars, is not covered by the warranty.

7 If the product serial number is changed, blurred, or torn, it is not covered by the warranty.



---

## 11 Abbreviations

---

BMS	Battery Management System
D	Depth
H	Height
W	Width
LCD	Liquid Crystal Display
LFP	LiFePO <sub>4</sub>
MOSFET	Metal-Oxide-Semiconductor Field-Effect Transistor
NTC	Negative Temperature Coefficient
PC	Personal Computer
PCB	Printed Circuit Board
PCS	Power Conversion System
RTU	Remote Terminal Unit
SOC	State of Charge